

**COSMO® Adhesives and Composite panels**  
*Special vehicle and caravan construction*

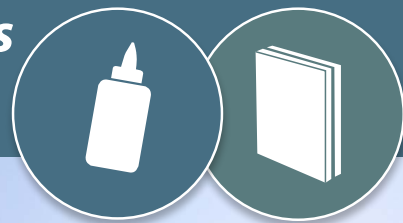

# Together toward success

A strong partner



Quality, service and high delivery reliability are the basic pillars of the success of our group of companies. We have continuously improved and further developed our portfolio in the last years; this also includes the acquisition of new companies. By now, about 325 employees at four sites participate in the success of our group.



## Company

By pooling the core competences of our business segments of adhesives and sandwich panels under a single roof, we are able to offer solutions from one source to our customers that are efficient and of high technical quality.

We are among the leading manufacturers in these two business segments in Europe and moreover, we also increasingly sell our products outside of Europe, such as in China, Russia and the USA.

## Company history

Since the company's foundation in 1815, Weiss has developed from a small glue producer to an internationally acting, industrial company for modern adhesive systems and composite panels. With a passion for quality and the aspiration to meet our customers' high expectations, we are a recognised and reliable partner on the market.

## Powerful product range

### Business area Adhesives



#### Durably firm joints

Traditional joining technologies like riveting, soldering, welding, or screwing, will increasingly be replaced by modern adhesive systems, resulting in many advantages.

Our product range includes more than 400 variants of surface and construction adhesive and superglues, as well as special adhesives for a wide variety of applications.

### Business area Composite panels



#### Unlimited possibilities for design

Our range of products includes more than 5,000 variants of composite panels. Because there is a large number of top coats and core materials available as well as the possibility of combining and processing them in many different ways, a vast number of creative designs results for the finished element.

### PUDOL Cleaning and care agent



#### Cleanliness refreshes your senses

PUDOL stands for convincing quality of special products in the field of commercial cleaning. In addition to a complete range of cleaning and care products for different applications, we are offering a comprehensive service with interesting solutions and benefits.

 A subsidiary of the Weiss Group

 Weiss is the only enterprise that produces adhesives and composite panels.

# Solutions for special vehicle and caravan construction

Weiss is offering highly loadable adhesive systems and composite panels tailored to the special requirements of the most diverse applications. On the basis of our long-term experience and the intensive exchange of experience with our customers in industry and trade, we have the possibility to continuously develop our products. With this, we are able to provide innovative application solutions to our customers and partners.

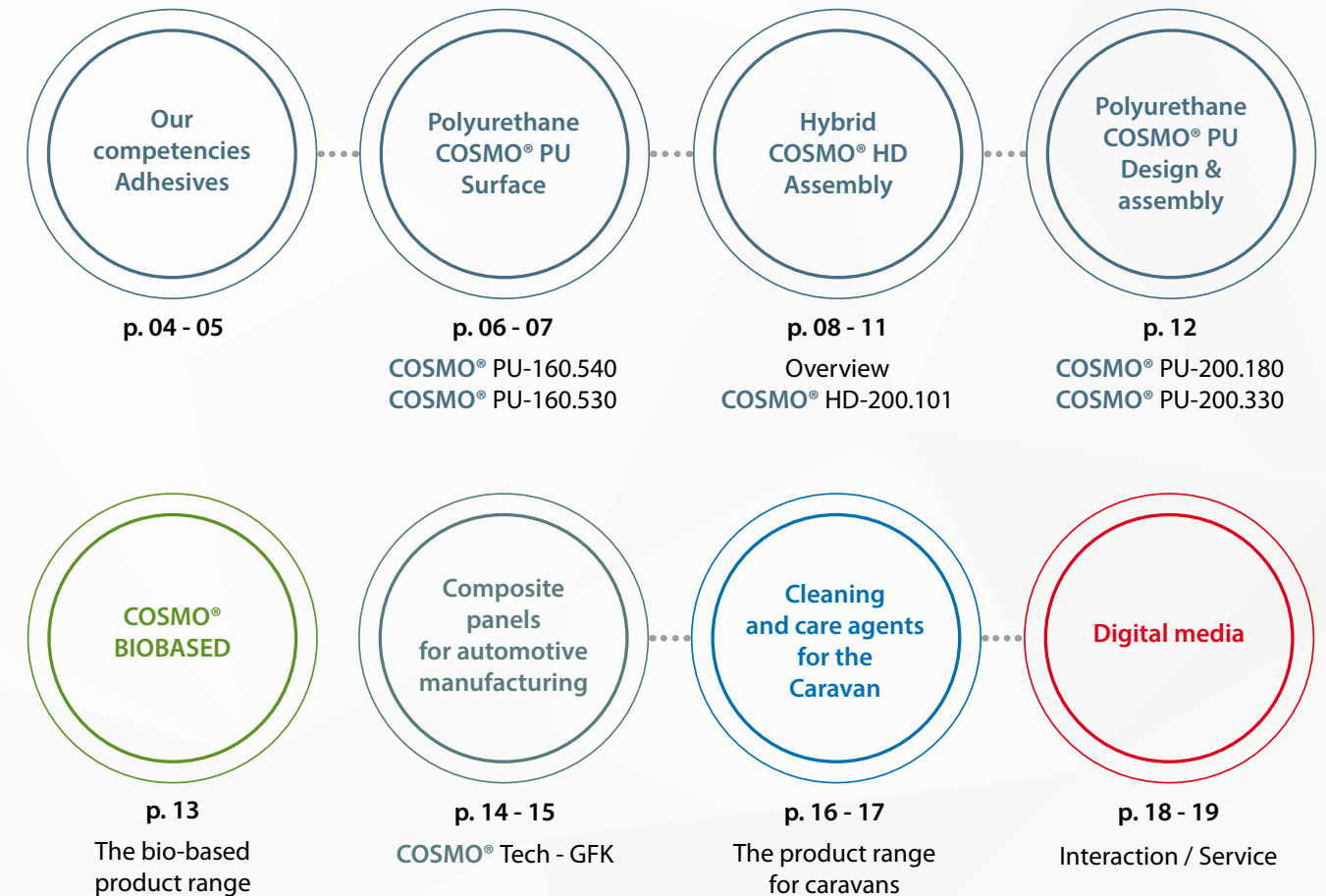

## Certifications

### Low-emission adhesives from Weiss / [www.emicode.de](http://www.emicode.de)

#### GEV-EMICODE®- licensed products

EMICODE® is a recognised standard for building products (adhesives, amongst others) promoting healthy living and is a quality label for the proof of low VOC-emissions. Products labelled with EMICODE® are modern, solvent-free, and low-emission building products.



### The "DIN-certified bio-based" label / [www.dincertco.de](http://www.dincertco.de)

A neutral and transparent quality label regarding the content of bio-based carbon and the product quality makes finding resource-efficient products easier. By using the "DIN-certified bio-based" label, it is certified that we use bio-based raw materials and undergo regular monitoring.



8C092



# Our competencies in adhesive technology

More than 200 years of experience



## Durably firm joints

Traditional joining technologies like riveting, soldering, welding, or screwing, will increasingly be replaced by modern adhesive systems, resulting in many advantages.

Our product range includes more than 400 variants of surface adhesive and construction adhesive and special adhesive for a wide variety of applications.

## Our adhesive systems & cleaning agents

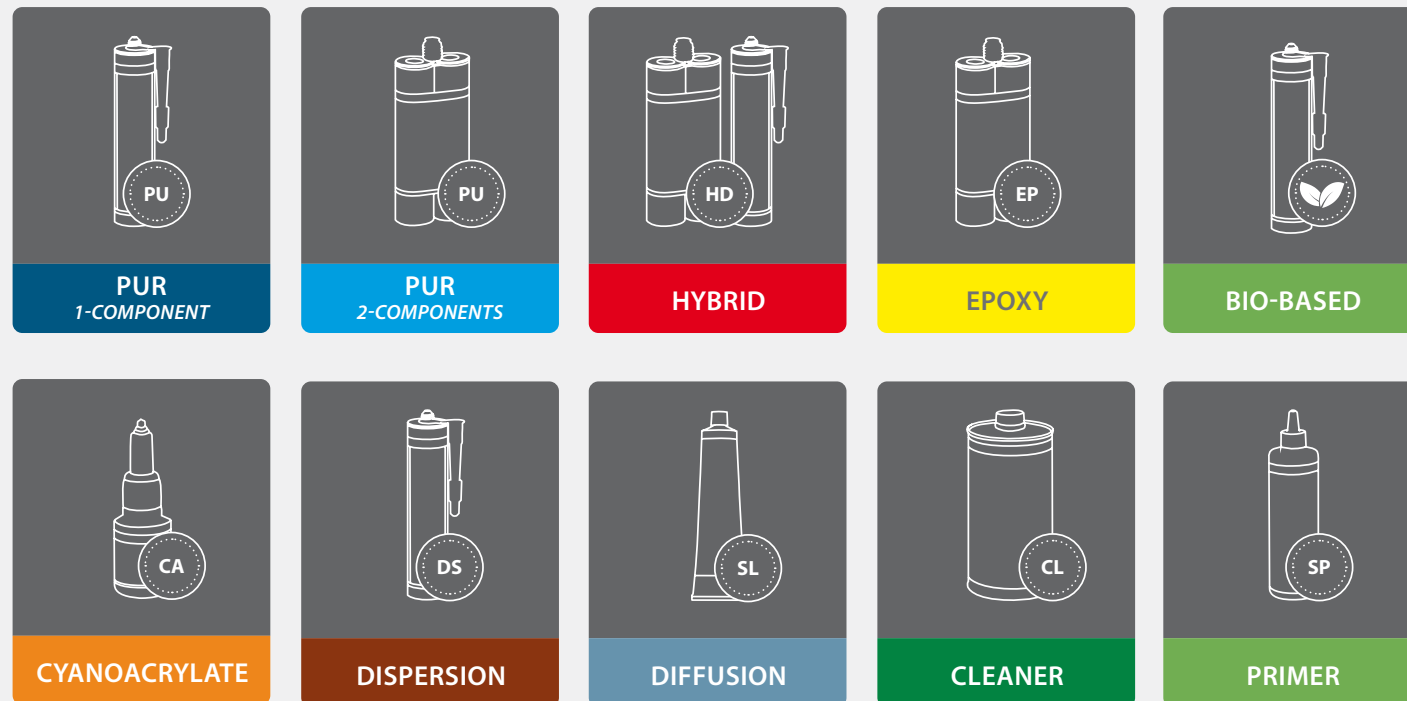

## Fields of application

Weiss is offering highly loadable adhesive systems for the most diverse fields of application. With the help of our adhesives, you ensure the required high quality of your product and achieve strengths that guarantee safe and durable bonding of your adherends also under extreme loads.



## Application engineering

It is very important to us to provide professional and innovative solutions with convincing advantages for production methods and with high efficiency in close cooperation with our customers. A team of chemists and application engineers with long-term experience in development, modification and application of adhesives will be on hand with help and advice for you.



## Customer-specific solutions

Our standard range of products consists of more than 400 types of adhesive for the most diverse applications. If, however, the suitable adhesive should not be available for you, we are offering a very special service. We are able to develop adhesive systems that will be customized with 100 % to your individual bonding tasks.



## Private label / individual layout

We would also like to produce and finish our products in accordance with your individual layout. We are offering special flexibility as well as long-term experience and respond with sensitivity on your wishes. Your own brand can profit from the high quality and reliability of our products.

## Certified quality

Our own quality tests as well as our cooperation with various testing institutes ensure the high quality of our products. We are working together with the following testing institutes:

- AWOK, Kaiserslautern
- DMT, Dortmund
- eco, Cologne
- Eurofins, Denmark
- Exova, Frankfurt
- FH Bielefeld
- IBP, Stuttgart
- IFAM, Bremen
- ift, Rosenheim
- ILAK, Wettengel
- ISEGA, Aschaffenburg
- Kiwa, Flörsheim
- MPA, Braunschweig
- TU, Berlin

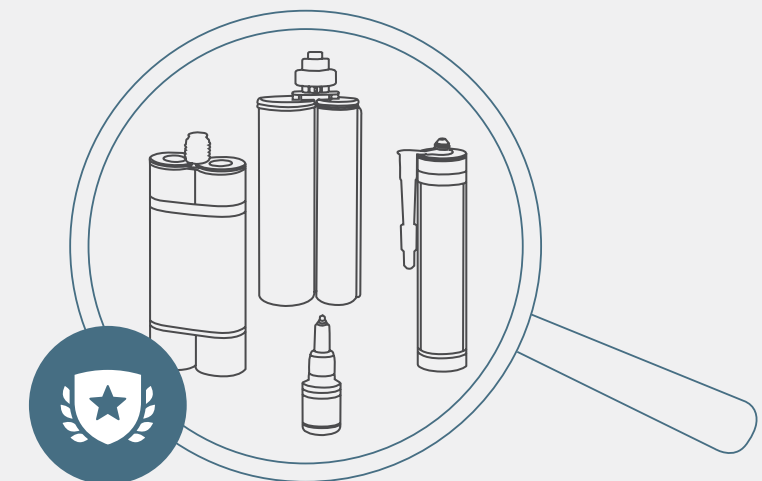



# COSMO® PU Polyurethane adhesives

Adhesives for extreme conditions

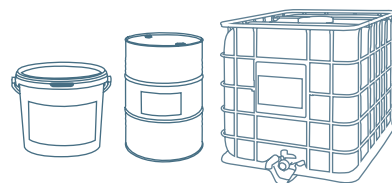

## Process-optimised 1-C-PUR surface adhesives

### COSMO® PU-160.540 and COSMO® PU-160.530

With the two 1-C-PUR adhesives **COSMO® PU-160.530** and **COSMO® PU-160.540** we have two adhesives in our range of products that can cover nearly all facets of surface bonding.

The **COSMO® PU-160.530** is always used in industrial fields where a variety of substrates that are hard to bond, like PVC, ABS, PS, PC or also metals and mineral substrates with fluctuating qualities can occur.

Briefly said: the safety backup for your bonding on site.

Due to its very good adhesion to many materials and qualities, this adhesive ensures a maximum of safety and gives more space for your process control.

If it shall be a specialist for the construction of side walls, e.g. on the basis of **GRP/XPS/GRP**, a fast **COSMO® PU-160.540** with a skinning time of 9 minutes has established itself. The optimum full curing from +35°C provides for fast reaching of functional strength. With this, a controlled, lean and fast production is accomplished.

These are important criterions for a cost-efficient manufacture of side wall elements.



### This corresponds with: COSMO® Tech - GFK composite panels for automotive manufacturing

Depending on the installation situation, different requirements on our lightweight building units can result. Therefore, specific material combinations are required. With **COSMO® Tech - GFK** we are offering you diverse options for the structure of ceiling elements, side walls and bottom plates (see page 14-15).

Please contact us! Please find our contact details on the rear side.

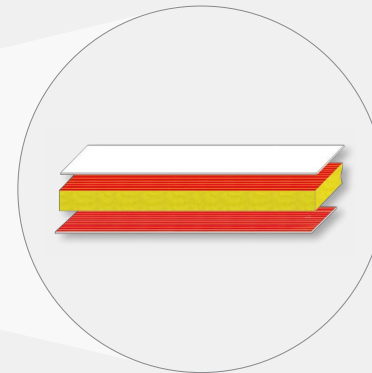
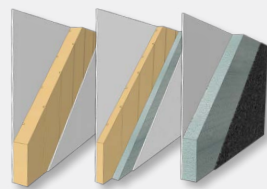

### The surface specialists

#### COSMO® PU-160.540

##### 1-C-PUR adhesive

###### Applications:

- Manufacture of sandwich and balustrade elements
- Bonding of surfaces
- Production of side walls of caravans

###### Special properties:

- Fast skinning time
- Tough-elastic adhesive joint
- Good penetration properties in EPS
- Solvent-free
- Expands (foams) during the curing process
- Good adhesive properties to GRP top coat and inner cores like XPS-, EPS- and PUR foams
- Good weather-resistance
- Compared to other 1-C-PUR adhesives of the COSMO® PU series, it faster cures fully at temperatures of >+35 °C
- Faster process times possible

#### COSMO® PU-160.530

##### 1-C-PUR adhesive

###### Applications:

- For universal use
- Manufacture of sandwich and balustrade elements
- Bonding of surfaces
- Diverse industrial fields

###### Special properties:

- Long processing time
- Outstanding variety of application possibilities
- Elastic adhesive joint
- Solvent-free
- Expands (foams) during the curing process
- Good adhesion properties with PVC, ABS, PS, PC, metals and mineral substrates
- Good bonding strength at heat
- Good weather-resistance
- Can be over-coated with many paint systems

### ! COSMO® PU surface adhesives for diverse application segments

When composite panels are manufactured, very special requirements are put on the adhesive system used because different technologies are applied for the application of adhesive and a large number of materials or material combinations are used. To be able to support you with the suitable adhesive in your individual production processes, we have developed a wide variety of systems with the most different characteristics referring viscosity, thixotropy, processing and pressing times.

#### Packaging:

1,080 kg IBC container

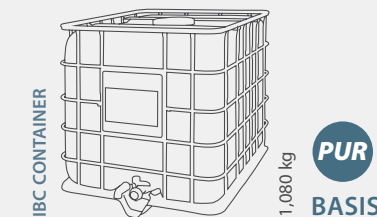

#### Packaging:

1,000 kg IBC container

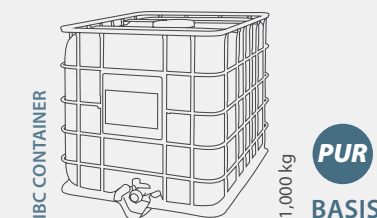



# COSMO® HD Hybrid Polymer Adhesives

## Environment-oriented bonding & sealing

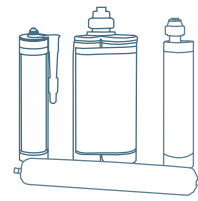

### Hybrid-polymer adhesives

This new generation of adhesives and bonding sealants has been developed on the basis of alternative raw materials. In contrast to conventional PUR construction and assembly adhesives, whose content materials are subject to labelling as per Ordinance on Hazardous Substances, we are offering the COSMO®S HD alternative system for the consequent, environment-oriented user.

### Structural bonding in automotive manufacturing

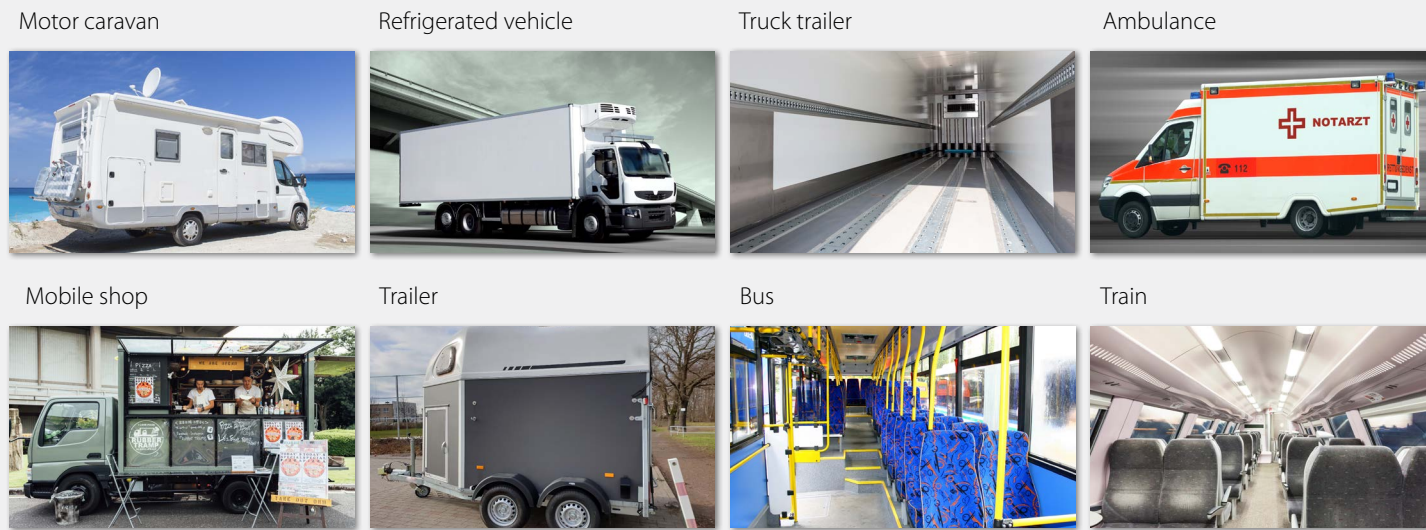
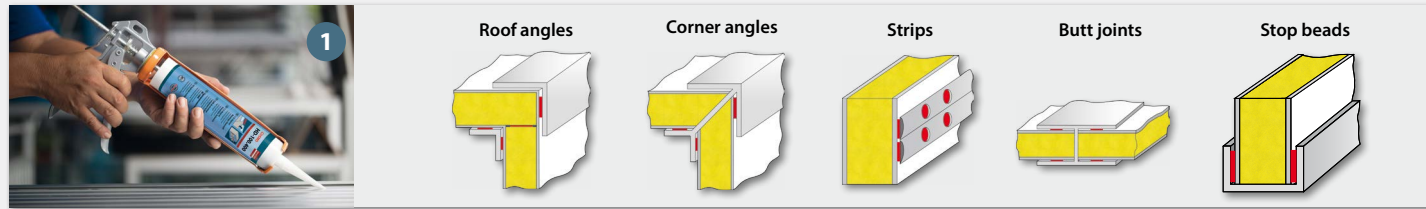

### Other fields of application



- 1 Bonding and sealing in automotive manufacturing
- 2 Assembly bonding
- 3 Skirting, laying of laminate and cable ducts
- 4 Mirror bonding
- 5 Stair construction and building trade
- 6 Tile repair
- 7 Glass bonding in the manufacture of furniture and display cabinets
- 8 Fixation of signs
- 9 Bonding and sealing of joint tapes
- 10 Bonding of EPDM films and profiles
- 11 Bonding of façade composite panels
- 12 Doubling of dry screed elements
- 13 Surface bonding of glass-fibre wall-papers or wood floorings
- 14 Dry finish and interior finishing
- 15 Solar and wind power plants
- 16 Window and door construction
- 17 Apparatus and plant construction
- 18 Diverse industrial fields
- 19 Shipbuilding

Sealing adhesives	Base	1	2	3	4	5	6	7	8	9	10	11	12	13	14	15	16	17	18	19	Particularities
COSMO® HD-100.400	1-C-MS	•	•	•	•	•	•	•	•			•			•	•	•	•	•	•	(•) Versatile
COSMO® HD-100.470	1-C-MS	•	•	•		•		•	•			•			•	•		•	•		Fast
COSMO® HD-100.800	1-C-MS	•	•	•	•	•	•	•	•						•		•	•	•		Powerfull
<b>Bonding sealants</b>																					
COSMO® HD-150.160	1-C-MS	•	•	•				•	•		•							•	•		Transparent
COSMO® HD-100.600	1-C-MS	•								•	•						•	•	•		Sealing
<b>Elastic assembly adhesives</b>																					
COSMO® HD-100.110	1-C-STP	•	•	•				•	•			•	•	•	•				•	•	Hardly inflammable
COSMO® HD-100.170	1-C-STP	•	•	•	•			•	•			•							•		Fast
COSMO® HD-100.220	1-C-STP	•	•	•	•			•	•			•		•					•	•	Powerful
COSMO® HD-100.500	1-C-STP	•	•	•	•	•	•	•	•			•							•	•	High tensile shear strength
COSMO® HD-100.510	1-C-STP									•											Window joint tape professional
COSMO® HD-200.101	2-C-STP	•	•	•		•	•	•	•			•		•	•	•	•	•	•	•	(•) Controlled
COSMO® HD-200.121	2-C-STP	•	•	•		•	•	•	•			•		•	•	•	•	•	•	•	(•) Controlled
COSMO® HD-200.201	2-C-MS	•	•	•		•		•	•			•		•	•	•	•	•	•		Controlled
<b>Elastic surface adhesive</b>																					
COSMO® HD-120.110	1-C-STP											•	•	•							Surface specialist

### Examples of materials

• Suitable (•) Of limited suitability



For pre-treatment we recommend our activator COSMO® CL-310.110.



# COSMO® HD Hybrid Polymer Adhesives

## Environment-oriented bonding & sealing

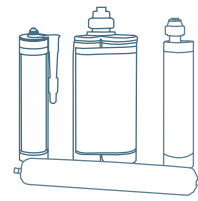

## 2-C-STP Construction Adhesive COSMO® HD-200.101

After nearly one year after the introduction, the state shows that the 2-C-STP Construction Adhesive **COSMO® HD-200.101** is a total success in which more and more customers trust. New projects could be implemented successfully, so that, in the meantime, the adhesive is not only being used for bonding of corpuses in the operator's cabin of motor caravans or in rail vehicles, but also for rear coach doors and bonding of frames in trucks and special vehicles and it is indeed used for bonding in the assembly of sports boats! The **COSMO® HD-200.101** completely convinced our customers, among others, in the intensive test mainly with its long-term behaviour and weather resistance under extreme conditions like the KATAPLASMA test\*.

The reservations regarding these more cost-intensive 2C system compared to a 1C system could be eliminated by faster and safer process times which is a clear advantage referring the requirements of DIN 2304.

We are sure that **COSMO® HD-200.101** is the technical benchmark in the 2C-STP sector. Also our customers agree with this estimate. Check this statement thoroughly! We would like to send you samples.

\* KATAPLASMA-Test: based on DVS 1618, but with extended test parameters: 14 cycles à 8 hours at -40°C, 8 hours at +20°C, 8 hours at +80°C

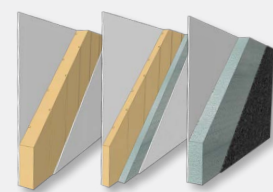

### This corresponds with: COSMO® Tech - GFK composite panels for automotive manufacturing

Depending on the installation situation, different requirements on our lightweight building units can result. Therefore, specific material combinations are required. With **COSMO® Tech - GFK** we are offering you diverse options for the structure of ceiling elements, side walls and bottom plates (see page 14-15). Please contact us! Please find our contact details on the rear side.



ROOF ANGLES

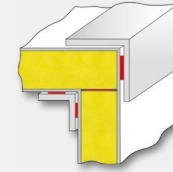

CORNER ANGLES

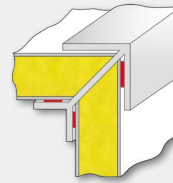

STRIPS

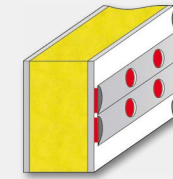

CROSS BUTT JOINTS

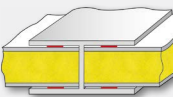

END PROFILES

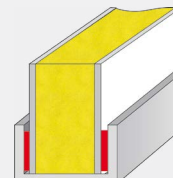

### The controlled adhesive

#### COSMO® HD-200.101 2-C-STP construction adhesive

##### Applications:

- Used for bonding and sealing in automotive and vehicle body manufacture
- Assembly bonding
- Skirting, laying of laminate and cable ducts
- Stair construction and building trade
- Bonding of façades (cassettes) - composite panels
- Glass bonding in the manufacture of furniture and display cabinets
- Solar and wind power plants
- Fixation of signs
- Apparatus and plant construction
- Diverse industrial fields

##### Special properties:

- Ideal for thick adhesive joints, without curing problems
- Elastic adhesive joint
- Full process control
- Fast and controlled curing
- High tear resistance
- Adding moisture to the adhesive joint is not necessary
- Adheres to a wide variety of substrates
- High weather-resistance
- Can be coated over
- H351 (R40) no marking required

#### For the preparation of bonding we recommend our activator COSMO® CL-310.110

##### Applications:

- Activation of bonding areas before bonding
- Activation of non-absorbent, porous and smooth substrates
- Activation of mineral surfaces

##### Special properties:

- It cleans and activates bonding surfaces
- It improves the bonding characteristics on PVC, ABS, PC, and GRP on surfaces of polyester or polyamide and on powder-coated surfaces
- It improves the ageing resistance of adhesive joints with concrete, aerated concrete, sandstone and building bricks

##### Packaging:

- 195 ml 2 : 1 UTAH cartridge
- 400 ml 2 : 1 side-by-side cartridge
- Other trading units on request

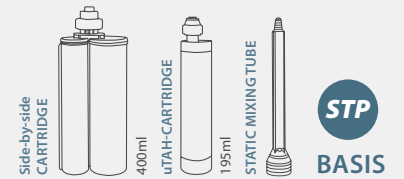

##### Other examples for application:

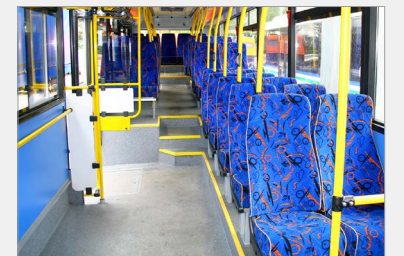

Manufacture of busses and trains

##### Packaging:

- 250 ml aluminium bottle
- 1,000 ml aluminium bottle

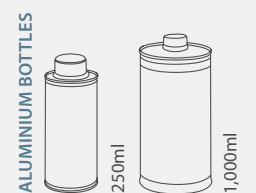

# COSMO® PU Polyurethane Adhesives

Adhesives for extreme conditions

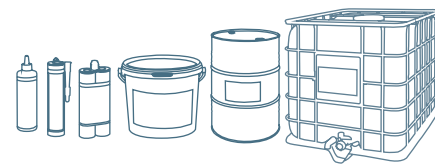

## Design & assembly

Due to their wide range of application possibilities, our one- and two-component-PUR adhesive systems are suitable for bonding of the most different materials and therefore, they are used in various industrial areas for structural bonding as well as for the assembly by the building industry and craftsmen.

## High-strength PU adhesives – High strength of adhesive joint



THE MULTI-TALENT

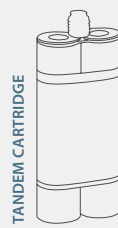

THE HIGH-STRENGTH ONE

! Also available with other reactivities!

Product	COSMO® PU-200.180	COSMO® PU-200.330
Emphasis	Allrounder	Tough-hard adhesive joint
Non-slump / pasty	Yes	Yes
Viscosity (+25°C)	140,000 mPa*s	25,000 mPa*s
Skinning time / pot life	90 minutes	50 minutes
Functional strength	420 minutes	300 minutes
Hardness Shore D	55	60
Hardness Shore A		
Tensile shear strength, +20°C	12.5 N/mm <sup>2</sup>	19 N/mm <sup>2</sup>
Solvent-free	√	√
EMICODE® EC1PLUS		
Can be coated over	√	√
Steering wheel / flame-resistant	☼	☼
Mixing unit	3.45 kg	910 g
Standard colours	beige	beige

# COSMO® BIO-BASED

The bio-based product range

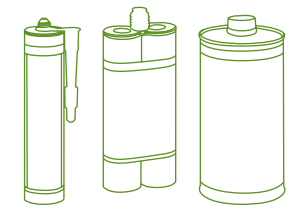

## The bio-based product range

Our bio-based adhesives and cleaners include a defined content of raw materials from renewable sources. Simultaneously, we could further optimise the properties.







**The versatile element for automotive and mini-caravan construction**

**COSMO® Tech - GFK**

Depending on the installation situation, different requirements on our lightweight building elements can result. Therefore, specific material combinations are required.



Automotive  
manufacturing

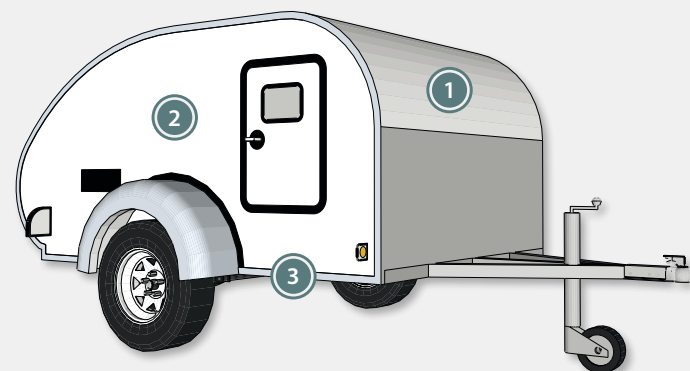

Mini-caravan construction

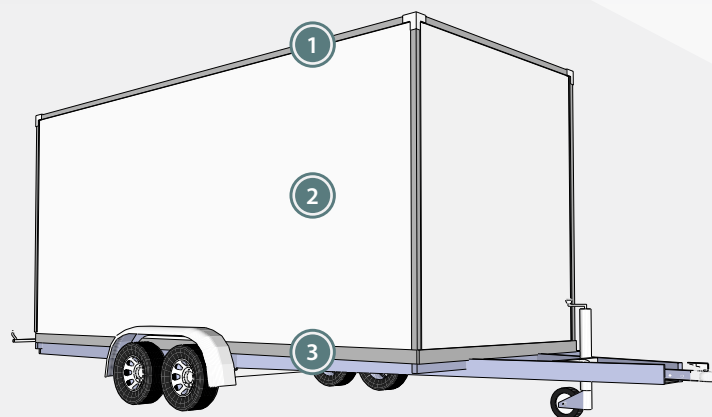

Trailer construction

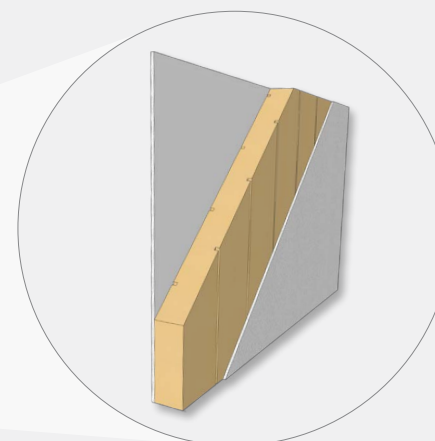

**1 Ceiling elements**

The core requirements on a ceiling element are low weight and high mechanical stiffness.

**Exemplary design of elements:**

GRP smooth / XPS and/or PUR core / GRP with/without gel coat

**Properties:**

- + High pressure and bending strength
- + Long-term water resistant
- + Swelling-resistant, i.e. no changes of dimensions
- + Minimum absorption of humidity

**2 Side walls**

The side walls ensure the stability of the whole Coffee structure. Depending on the application, however, further properties, e.g. good durability of insulation, could be relevant.

**Exemplary design of elements:**

GRP smooth / XPS, PUR and/or TK core / GRP with/without gel coat

**Properties:**

- + Screwable in combination with TK core
- + Individual design as per specification

**3 Floor elements**

Despite of low weight, a bottom plate must have high strength and good wearing resistance. These requirements can be met depending on the application by selecting of suitable core materials or top coats.

**Exemplary design of elements:**

GRP anti-slip / XPS, PUR and/or TK core / GRP smooth

**Properties:**

- + High pressure and bending strength
- + Long-term water resistant
- + Slipping class 13
- + Environmentally-friendly inserts (, TK is 100% recyclable)
- + Swelling-resistant, i.e. no changes of dimensions
- + Minimum absorption of humidity

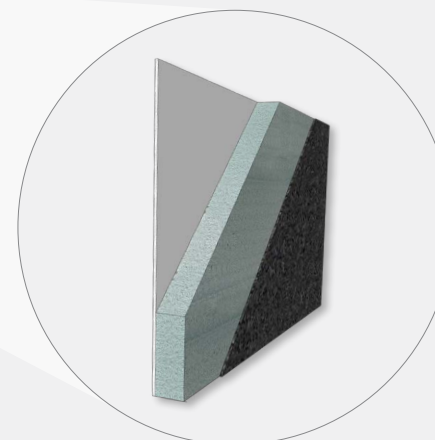
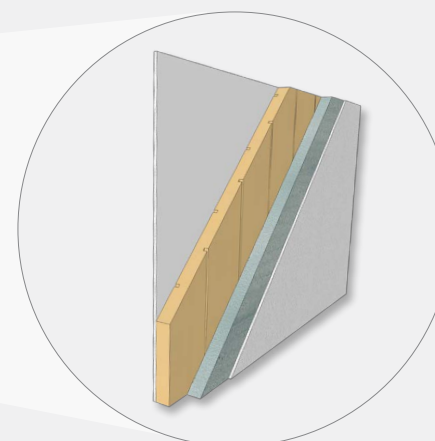

**This corresponds with:**

COSMO® HD-100.800, COSMO® HD-100.400 and COSMO® HD-200.101 for automotive and mini caravan construction. You can find more information in our brochure "FOCUS ON Weiss 2.0".

**The interior finishing**

For the application inside of the vehicle we recommend our COSMO® Plan S Integral rigid foam panel (see page 33).

**Formats (mm):**

Dimensions on request.

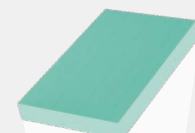
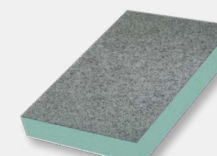
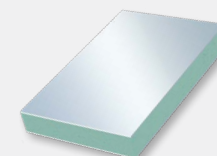
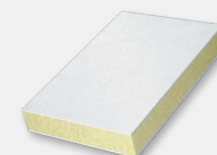

SECOND SOURCE



### PUDOL Caravan care set – Outdoor

The professional combination set consisting of our Caravan Shampoo, Professional Rim Cleaner and Multi-Cloth, including bucket and sponge for cleaning and maintaining the outside of caravans.

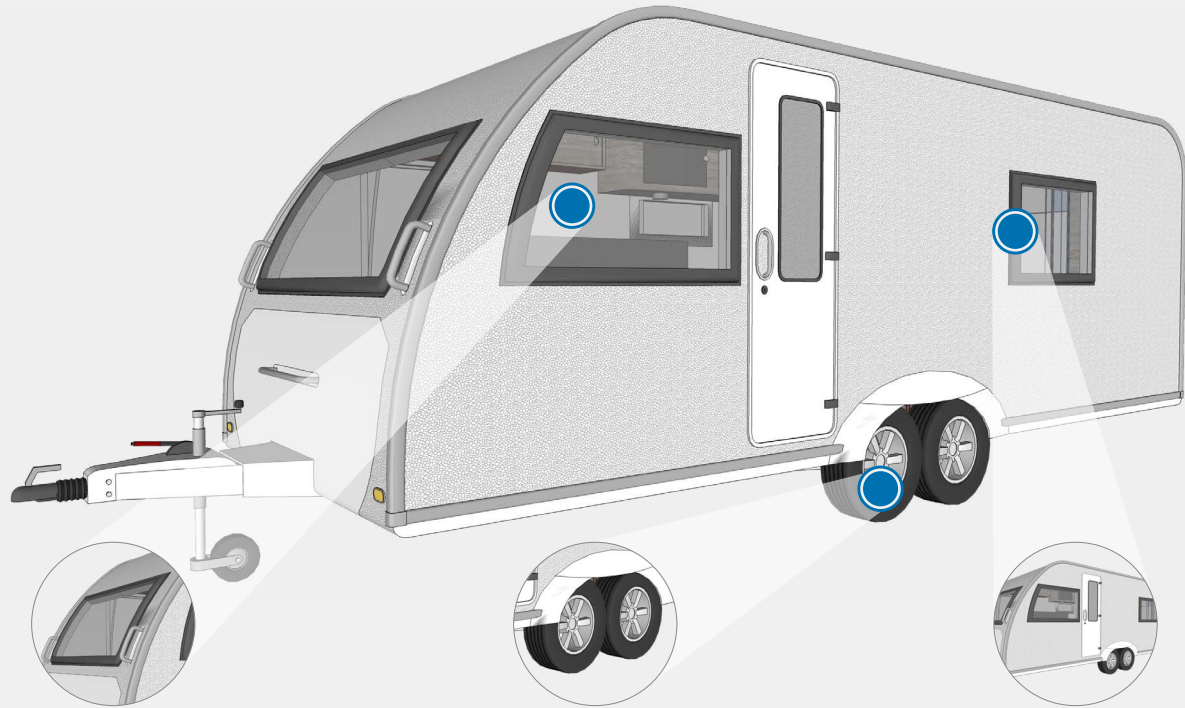

**Packaging:**

- 2 x 200 ml bottle
- 1 x multi-cloth bucket
- 1 x sponge
- 1 x bucket



**1 Caravan shampoo**  
SOFT

**Applications:**

As an addition for manual washing of caravans. Also suitable for cleaning of panes as well as plastic parts inside and outside.

**Special properties:**

- Highly concentrated
- Mild to surfaces
- Neutral shampoo with good dirt-dissolving and degreasing features
- Strongly foaming
- Does not attack plastics
- Mild for the hands
- Water runs off smoothly
- It dries free from striation

**2 Professional Rim Cleaner**  
POWER

**Applications:**

A special cleaner for all lacquered aluminium and steel rims.

**Special properties:**

- Highly concentrated
- It is strongly dirt-dissolving and degreasing, also for intractable pollutions like brake dust or oil residues.

**3 Multi-Cloth**  
POWER

**Applications:**

Cleaning cloth for universal use when on the way for thorough and fast cleaning of the most surfaces without the need for water, soap and cleaning tools. Thoroughly and carefully removes strongest pollutions, e.g. brake dust, oils, and grease.

**Special properties:**

- Water-free cleaning
- Strongly wear-resistant fleece, lint-free
- Multi-purpose



**This corresponds with: the surface specialists for the caravan construction**

For bonding of our composite panels in the production of side walls for caravans we recommend our surface specialists **COSMO® PU-160.540** und **COSMO® PU-160.530** (see page 6-7). Please contact us! Please find our contact details on the rear side.



### PUDOL Caravan care set– indoor

The professional combination set consisting of our Orange Cleaner, Microsoft Care System and Multiclean including bucket and microfibre cloth for cleaning and maintaining the inside of caravans.

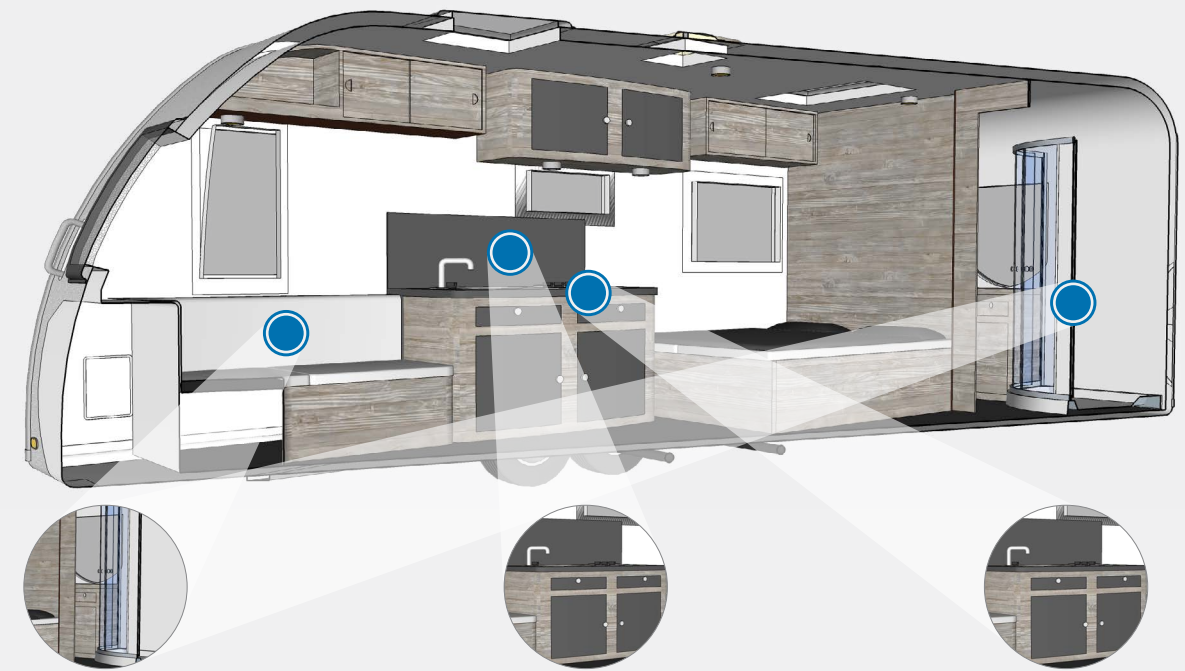

**Packaging:**

- 3 x 200 ml bottle
- 1 x microfibre cloth
- 1 x bucket



**1 Orange cleaner**  
FRESH

**Applications:**

Multipurpose cleaner for colour spots, spots from chewing gum, spots on upholstery, carpet floorings, clothes, from ballpoint pens, ink, nail varnish and rubber abrasion on floorings. It has a concentrated effect as odour neutraliser, e.g. in WCs, in garbage bins or in all places where unpleasant odours can occur.

**Special properties:**

- Highly concentrated
- Odour neutralising

**2 Microsoft System Care**  
CARE

**Applications:**

It is suitable, e.g., for the following surfaces: All metals, plastics, Resopal, polyester, ceramics, porcelain, glass, enamel, stainless steel, chromium, copper, brass, nickel and silver.

**Special properties:**

- Highly concentrated
- Acid-free
- It contains slightly smelling solvents
- It protects from corrosions and prevents tarnishing of metals, water stains, fingerprints and sticking of dust on materials
- Water drips off
- It does not leave any scratches or grooves

**3 Multiclean**  
POWER

**Applications:**

Alkaline power cleaner and degreaser

**Special properties:**

- Highly concentrated
- Strong dirt-dissolving and degreasing effect
- Solvent-free
- Free from CFC
- Non-flammable
- It has optimum wetting and emulsifying effect
- Moderate foam development

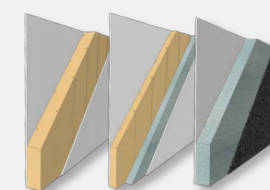

**This corresponds with: COSMO® Tech - GFK composite panels for automotive manufacturing**

Depending on the installation situation, different requirements on our lightweight building units can result. Therefore, specific material combinations are required. With **COSMO® Tech - GFK** we are offering you diverse options for the structure of ceiling elements, side walls and bottom plates (see page 14-15). Please contact us! Please find our contact details on the rear side.





### Always up to date

We are happy to bring our products and fields of application closer to you at the [www.weiss-chemie.de](http://www.weiss-chemie.de) and to keep you informed about the latest developments.

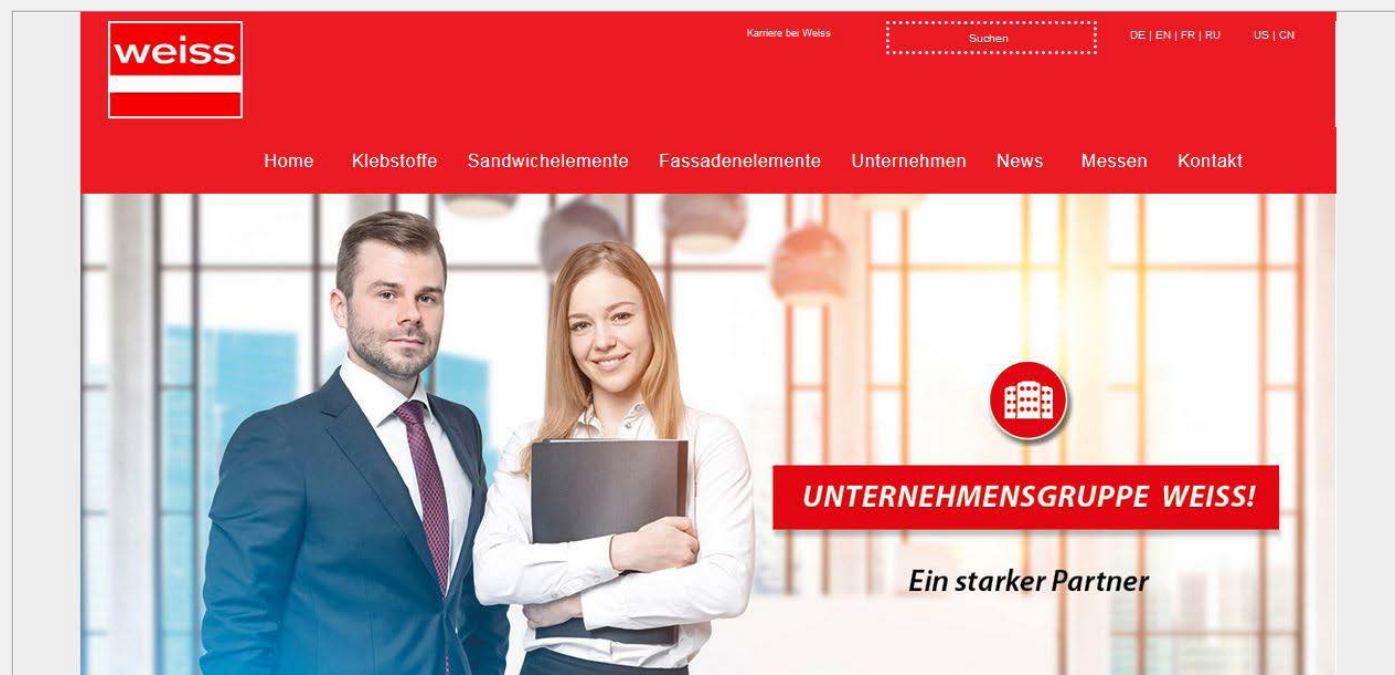

#### Current issues

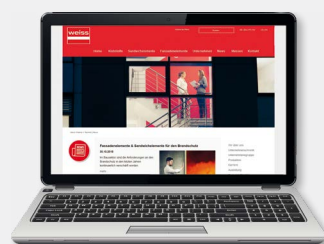

- + By our slide show and our News column you are always informed on current topics and remain up to date.

#### Newsletter

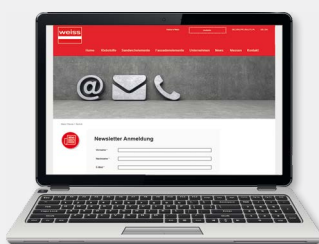

- + With the newsletter issued by Weiss you will never miss the innovations of products and applications. Conveniently register for this newsletter via our website.

#### Service / Downloads



- + In our Product / Application area, you will directly find the appropriate contact person. In addition, you can easily download all print media as well as data sheets.

#### Trade fairs



- + Visit us at our booths at the national and international trade fairs and obtain information online about all details and facts referring our participations in trade fairs.

### PUDOL – Cleaning and care agent

- + **PUDOL** stands for convincing quality of special products in the field of commercial cleaning. In addition to a complete range of cleaning and care products for different applications, we are offering a comprehensive service with interesting solutions and benefits. Visit our website: [www.pudol.de](http://www.pudol.de)



Cleanliness refreshes your senses



### Customer support

Flexibility and the creation of customer-oriented problem solutions count among the elementary objectives of our company. Therefore, it is very important to us to provide professional and innovative solutions with convincing advantages for production methods and with high efficiency in close cooperation with our customers.

A highly motivated team of application engineers, materials testers and chemists with long-term experience in development, modification, materials science, building physics and application of adhesives and composite panels is on hand with help and advice for you.



#### Application engineering Adhesives



- + Support with creating the requirements specification
- + Expert advice on the selection of adhesives
- + Optimisation tips for the design of the bonding surfaces
- + Rationalisation proposals for work flows
- + Recommendation of suitable dosing units as well as application and pressing technology
- + Optimisation of workplaces when using adhesives
- + Training for workers and specialist dealers; technical lectures
- + Creation and modification of adhesives in our Research and Development department



#### Test possibilities in our application technology and internal research and development department

- + With our own test facilities we are not only able to test in compliance with DIN and EN standards but we can also evaluate your components (component sizes) under operating conditions in a practice-oriented way. In addition, we ensure the high quality of our products on the basis our cooperation with the most diverse testing institutes.



#### Application engineering Composite panels



- + Individual element construction
- + Application-specific material components
- + Project-related proposals for solutions
- + Selection of materials in accordance with construction-physical requirements and conditions



#### Test possibilities in our Technical Centre

- + **Materials tests:**
  - Storage at alternating climate
  - 3-point bending rigidity
  - Perpendicular tensile strength
  - Colour measurement
  - Storage in water
  - Determination of U-values
- + Furthermore, we are working together with famous testing institutes that are responsible for fire protection and sound insulation.



Are you also a member of LinkedIn? Then follow us. We post interesting news at regular intervals. You will find us at:  
**Weiss Chemie + Technik GmbH & Co. KG**

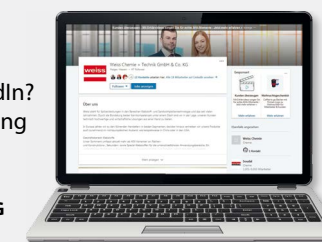



# An overview of our range of products

Experience quality on a completely new level, with the powerful products by Weiss:



## **COSMO® Adhesives**

*Durably firm joints*

**COSMO® CA** (Cyanoacrylates)  
**COSMO® PU** (Polyurethane adhesives)  
**COSMO® CL** (Cleaning agents)  
**COSMO® SL** (Dispersion adhesives)  
**COSMO® HD** (Hybrid adhesives)  
**COSMO® EP** (Epoxy-resin adhesives)  
**COSMO® DS** (Dispersion adhesives)  
**COSMO® SP** (Service products)

### **Fields of application**

- + Windows and doors
- + Transportation / Marine engineering
- + Industry
- + Assembly
- + Dry construction
- + Airtight bonding
- + Wood / Furniture industry
- + Container construction
- + Composite panels
- + Fire protection
- + Advertising industry

### **Do you have any questions?**

#### **Our Service Center**

##### **Business area Adhesives:**

+49 (0) 2773 / 815 - 255

+49 (0) 2773 / 815 - 274



## **COSMO® Composite panels**

*Unlimited possibilities for design*

**COSMO® Therm** (heat-insulating)  
**COSMO® Silent** (sound insulating)  
**COSMO® Protect** (burglar/penetration resistant)  
**COSMO® Design** (grooved)  
**COSMO® Tech** (individual)  
**COSMO® Frame** (frame widening)

### **Fields of application**

- + Window and façade
- + Door construction
- + Industry
- + Automotive manufacturing
- + Trailer construction
- + Partition panel construction
- + Gate construction
- + Container construction
- + Energy conservation
- + Fire protection
- + Burglar resistance
- + Sound proofing

### **Do you have any questions?**

#### **Our Service Center**

##### **Business Area Composite panels:**

+49 (0) 2773 / 815 - 311

#### **Our Service Center**

##### **Business area Façade:**

+49 (0) 5245 / 9241 - 21



## **PUDOL Cleaning and care agent**

*Cleanliness refreshes your senses*

### **PUDOL SOFT**

Mild cleaning agent for sensitive materials

### **PUDOL CARE**

Maintenance product for high gloss and hygiene

### **PUDOL POWER**

Powerful cleaning agent for extreme pollution

### **PUDOL FRESH**

Cleaning agent for cleanliness and fresh air

### **Fields of application**

- + Flooring
- + Sanitary installations
- + Clothing care
- + Foodstuff industry
- + Household and gastronomy
- + Windows and glass
- + Dishwasher
- + Carpet and upholstery
- + Industry and workshop
- + Cars
- + Skin cleaning
- + Skin protection

### **Do you have any questions?**

#### **Our Service Center PUDOL:**

+49 (0) 2743 / 9212 - 0

**weiss**

Plant I  
Weiss Chemie + Technik  
GmbH & Co. KG  
Hansastr. 2  
D-35708 Haiger

Phone: +49 (0) 2773 / 815 - 0  
Fax: +49 (0) 2773 / 815 - 200  
E-mail: ks@weiss-chemie.de

[www.weiss-chemie.de](http://www.weiss-chemie.de)

Plant II  
Weiss Chemie + Technik  
GmbH & Co. KG  
Siemensstr. 8  
D-33442 Herzebrock-Clarholz

Phone: +49 (0) 5245 / 9241 - 0  
Fax: +49 (0) 02773-815-300  
E-mail: se@weiss-chemie.de

**PUDOL**



**A subsidiary of the  
Weiss Group**

Pudol Chemie GmbH & Co. KG  
Bahnhofstr. 2  
D-57520 Niederdreisbach

Phone: +49 (0) 2743 / 9212 - 0  
Fax: +49 (0) 2743 / 9212 - 71  
E-mail: info@pudol.de  
[www.pudol.de](http://www.pudol.de)

*Cleanliness refreshes your senses*

*made by weiss*